

Misure / Measures

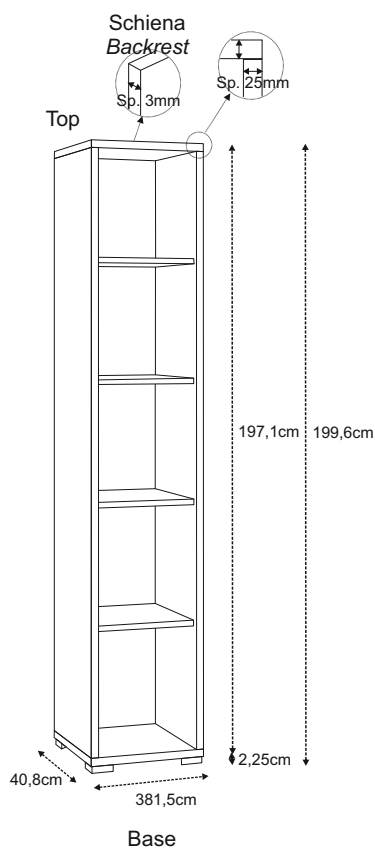

Dettagli / Details

- Struttura materiale in truciolare nobilitato
- Piedini verniciati cromo satinato
- Interno: 2 ripiani regolabili e 2 fissi
- Mobile in kit
- *Material structure in engineered wood*
- *Chrome-plated feet*
- *Inside: 2 adjustable shelves and 2 fixed*
- *Kit furniture*

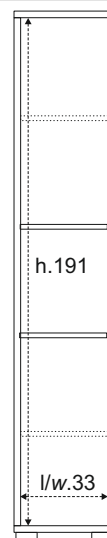

Componenti / Elements

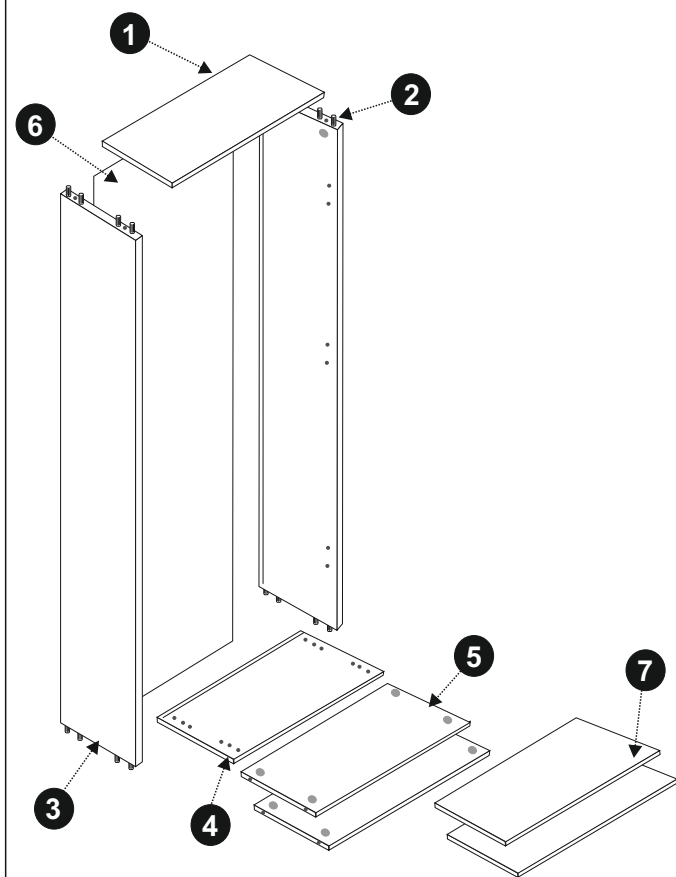









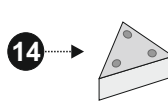

Pos.

Pezzi / Pcs

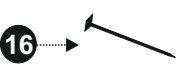
Descrizione / Description

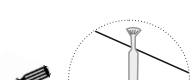
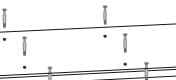
Pos.	Pezzi / Pcs	Descrizione / Description
1	1	Coperchio (381,5 x 408 x 25mm) <i>Cover (381,5 x 408 x 25mm)</i>
2	1	Fianco dx (1921 x 408 x 25mm) <i>Rh Side (1921 x 408 x 25mm)</i>
3	1	Fianco sx (1921 x 408 x 25mm) <i>Lh Side (1921 x 408 x 25mm)</i>
4	1	Base (381,5 x 408 x 25mm) <i>Base (381,5 x 408 x 25mm)</i>
5	2	Tramezza (330,5 x 374 x 18mm) <i>Partition shelf (330,5 x 374 x 18mm)</i>
6	1	Schiena (1960 x 347,5 x 3mm) <i>Backrest (1960 x 347,5 x 3mm)</i>
7	2	Ripiano (328,5 x 374 x 18mm) <i>Shelf (328,5 x 374 x 18mm)</i>

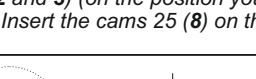
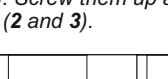
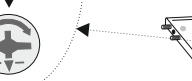
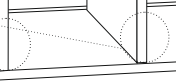
Accessori / Equipment	Pos.	Pezzi / Pcs	Descrizione / Description
 8 → 	8	8	Eccentrico 25 - Cam 25
 9 → 	9	8	Eccentrico 18 - Cam 18
 10 → 	10	16	Perno per Eccentrico - Cam Bolt
 11 → 	11	16	Tappino per Eccentrico - Cam cover cap
 12 → 	11	22	Reggipiani - Support shelves
 13 → 	13	4	Tappino copriforo - Hole cover cap
 14 → 	14	4	Piedino - Foot
 15 → 	15	12	Vite TC 4,5x16 - Screw TC 4,5x16
 16 → 	16	10	Chiodino - Nail

Istruzioni di montaggio / Assembly Instructions

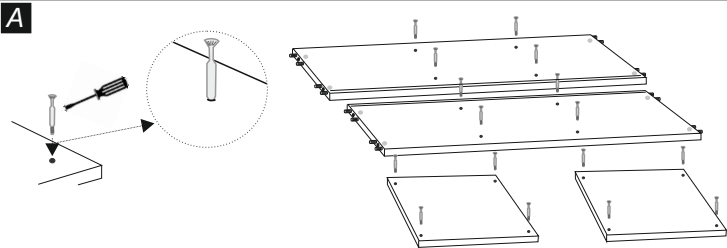

Avvitare i perni per eccentrico (**10**) negli appositi fori posti su: coperchio (**1**), base (**4**), sui fianchi dx (**2**) e sx (**3**) (nella posizione desiderata). Avvitarli sino a fine corsa. Inserire sui fianchi (**2** e **3**) gli eccentrici 25 (**8**).
*Screw the cam bolts (**10**) into the holes on: cover (**1**), base (**4**), Rh and Lh sides (**2** and **3**) (on the position you desire). Screw them up at the end of the stroke. Insert the cams 25 (**8**) on the sides (**2** and **3**).*

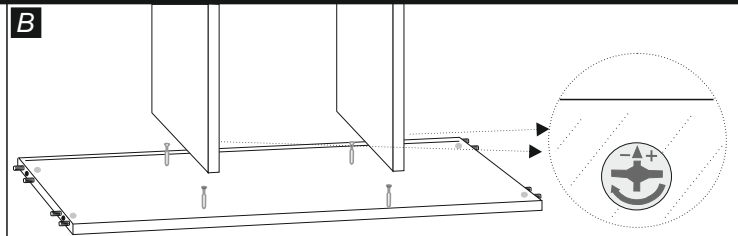

Appoggiare il fianco sx (**3**) su un piano come da figura ed inserire gli eccentrici 18 (**9**) nei fori sulle tramezze (**5**) e sul fianco sx (**3**) con la freccia rivolta verso i fori posti sui bordi. Inserire quindi le tramezze (**5**) sul fianco.
*Lay out the Lh side (**3**) on a flat surface and insert the cams 18 (**9**) in the appropriate holes on partition (**5**) and the Lh side (**3**). Then insert on the side the partition shelves (**5**).*

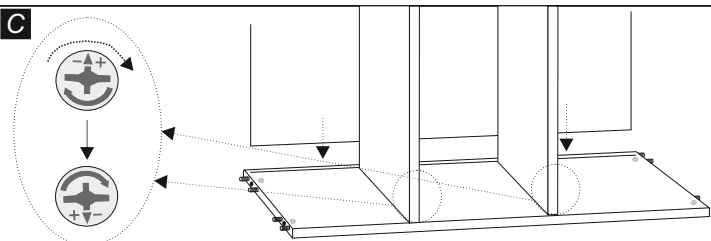

Ruotare gli eccentrici posizionati sulle tramezze (**5**) in senso orario in modo da fissarle. Inserire la schiena pieghevole (**6**) sul fianco nell'apposita guida.

*Turn the cams placed on the partition sides (**5**), in a clockwise direction so as to secure them to the side. Insert now the folding backrest (**6**) on the side, sliding it into the guides on the partitions.*

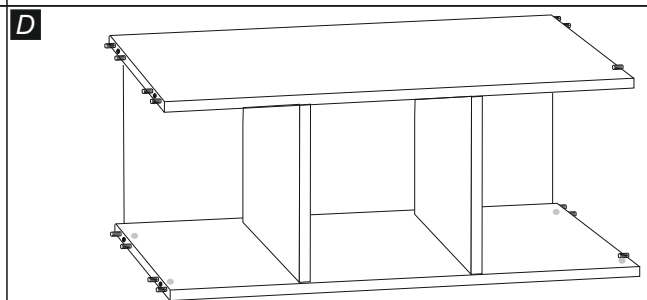

Inserire ora il fianco dx (**2**) sulla struttura facendo attenzione a far combaciare la guida del fianco alla schiena ed i perni sul fianco ai fori sul bordo delle tramezze (**5**). Inserire ora gli eccentrici sui restanti fori delle tramezze come indicato al punto **B** e fissarli come al punto **C**.
*Insert now the Rh side (**2**) on the structure being careful to match up the guide of the side back and the cam bolts on the side with the holes on the edge of the partitions (**5**). Now insert the cams on the remaining holes in the partitions as indicated at point **B** and secure them as the point **C**.*

E

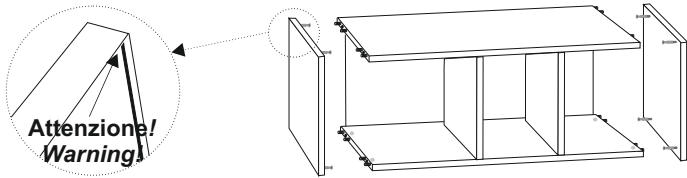

Sistemare ora i gli eccentrici sul fianco dx come indicato al punto **B**, ed inserire il coperchio (1) e la base (4) infilandoli lateralmente sui due fianchi con i perni per eccentrico (10). Quindi fissarli come descritto al punto **C**.

Attenzione: non rompere i bordi alle estremità della fresata.

*Insert the locking rings on the Rh side as indicated in point **B**, and insert the cover (1) and the base (4) inserting them laterally on the two sides with the cam bolts (10). Then secure them as described in point **C**.*

Warning: do not break the edges at the ends of the milled.

F

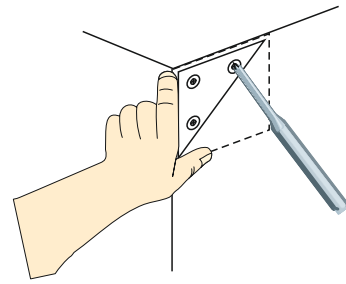

Utilizzare la sagoma ritagliata precedentemente fornita insieme ai piedi e posizionarla su un angolo della base. Fare dei fori nei tre centri con un punteruolo per agevolare la penetrazione delle viti. Ripetere l'operazione sugli altri angoli. **ATTENZIONE: agire sulla base, non sul top.**

*Use the shape cropped previously supplied with the feet and turning on the corners of the base flush with the sides. Mark the holes in the three centers with an awl to facilitate the penetration of the screws. Repeat the operation on the other corners. **WARNING: act on the base, not on the top.***

G

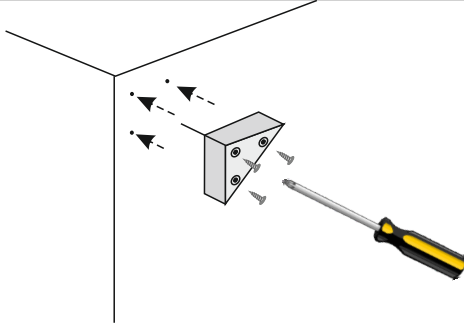

Posizionare ora il piede (14) sui fori segnati sull'angolo della base come mostrato in figura. Fissare il piede con le viti 4,5x16 (15) (3 viti per piede). Ripetere l'operazione sugli altri angoli con i restanti piedi.

Support now the foot (14) on the holes marked on the corner of the base on respective holes shown of the foot. Fix the foot using screws 4,5x16 (15) (3 screws for foot). Repeat the operation on the other corners with the remaining feet.

H

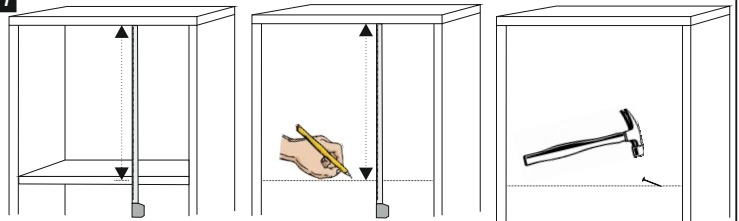

Per una migliore adesione della schiena si consiglia di fissarla alle tramezze (5): posizionare in piedi il mobile e, dalla parte anteriore, prendere le misure interne dal coperchio al centro delle tramezze; sul retro del mobile, con le misure prese precedentemente, partendo dall'alto da sotto il coperchio segnare due linee sulla schiena; piantare infine i chiodini (16) equidistanti sulle linee.

For a better adhesion of the backrest it is recommended to secure it to the partitions (5): place vertically the cabinet and, from the front, take the internal measures from the top to the middle of partition; on the back, with the measures taken previously, starting from the top from beneath the top mark two lines on the backrest; inserting finally nails (16) equidistant on line

I

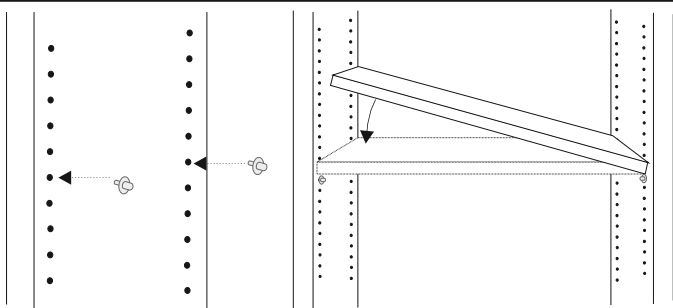

Inserire i reggipiani (12) sui rispettivi fori posti sui fianchi dx e sx all'altezza desiderata. Inserire il ripiano inclinato (7) sui reggipiani (12) inseriti precedentemente sui fianchi, quindi riportare in posizione orizzontale il ripiano.

Insert the support shelves (12) in the appropriate holes posts on the sides left and right to the heights you wish. Slip now inclined shelf (7) above the supports (12) previously inserted on sides, tilting between the sides in the area above the supports, then back in a horizontal position.

L

M

N

Scheda Prodotto / Product Sheet

PRODOTTO PRODUCT	COMPONENTI COMPONENTS	TIPOLOGIA E MATERIALI PER LA STRUTTURA TYPOLOGY AND MATERIAL FOR THE STRUCTURE	TIPOLOGIA E MATERIALI DI RIVESTIMENTO, SUPERFICI TYPOLOGY AND COATING MATERIAL SURFACES	TIPOLOGIA E MATERIALI PER I BORDI TYPOLOGY AND MATERIAL FOR THE EDGES
Mobile Cabinet	Fianchi Sides	Truciolare nobilitato Engineered wood	Carta impregnata con resine melaminiche Paper impregnated with melanine resins	Carta impregnata con resine termoplastiche e termoindurenti o PVC Paper impregnated with thermoplastics and thermosetting resins or PVC
	Top			
	Base			
	Pianetti e Tramezze Shelves and Partitions			
	Schiena Backrest	Pannello fibrolegnoso Panel wood fiber	Trattamento superficiale idrofobizzante con paraffina Surface treatment hydrophobicizing with paraffin	

ALTRE CARATTERISTICHE OTHER CHARACTERISTICS	USO USE	PULIZIA CLEANING	SMALTIMENTO DISPOSAL
<p>Materiale di classe E1: bassa emissione di formaldeide. Questi pannelli possono essere utilizzati senza causare una concentrazione di equilibrio nell'aria della camera di prova (definita nella norma UNI EN 717-1) maggiore di 0,1 ppm, limite raccomandato all'Organizzazione Mondiale della Sanità per gli ambienti di vita e soggiorno.</p> <p><i>Material class E1: low formaldehyde emissions Class E1 panels can be used without causing an equilibrium concentration in the air in the test chamber (defined in the UNI EN 717-1) greater than 0.1 ppm, limit recommended by the World Health Organization for life and living environments.</i></p>	Mobile multiuso Multiuse cabinet	Utilizzare panno inumidito con alcool diluito o con prodotti per la pulizia delle superfici lavabili, purché privi di abrasivi e/o solventi. <i>Use cloth moistened with alcohol diluted or with cleaning products for the washable surfaces, if they are free of abrasives and/or solvents</i>	Al termine del ciclo di vita, il prodotto può essere conferito alla raccolta differenziata o speciali piattaforme RSU <i>At the end of the life cycle the product may be conferred on the differentiated collection or special platforms RSU</i>

ATTENZIONE

Se al momento dell'apertura della confezione dell'imballo si evidenziassero anomalie delle parti strutturali occorre contattare il fornitore prima del suo utilizzo

WARNING

If at the time of the opening of the packaging, it yields anomalies of structural parts you need to contact the supplier before its use.



SARMOG s.r.l.

Via Pizzamiglia, 7
42016 S.Girolamo di Guastalla (RE) - Italy

Tel +39 0522 228058
Fax +39 0522 228442

Web www.sarmog.com
E-mail info@sarmog.com

SARMOG
L I F E S T Y L E H O M E